



Automatic, Security and Manual Revolving Door Systems

2013 Edition





Beautiful • Brilliant • Energy Efficient

Horton Automatics offers a wide range of automatic, security and manual revolving door systems to meet facility traffic demands, control energy expenses, and provide architecturally appealing entrances.

Automatic: Horton Automatics standard offering includes two, three, and four-wing automatic door systems. The two-wing offers the largest compartment size easily accommodating large volumes of traffic, whether for commercial or institutional applications.

The three-wing is most commonly used for providing fast and efficient traffic flow.

The four-wing is offered in standard and all-glass configurations and used for unique applications.

Security: Horton's security systems include one and two-way secure access. The one-way is ideal for transporting pedestrians from secure to non-secure areas in applications such as airports.

The two-way is ideal for controlled access such as pharmaceutical labs. Both systems free up security resources eliminating the need for manned stations.

Manual: Horton also offers manual revolving door systems in three and four-wing configurations.

Options: Horton ties this altogether with either throat or center connected configurations showcasing round canopies and segmented drums providing aesthetically engaging solutions.

Horton's independent distribution network completes the product offering with superior installation and service.

Product Functions



Automatic



Manual



Security



Energy Efficient

What Sets Horton Apart



Advantages of Segmented® vs. Round Drum:

1. Segmented® drums allow for flat or insulated glass or solid panels
2. Segmented® drums have lower installation costs than round drums
3. Segmented® systems allow for immediate glass replacement when needed
4. Segmented® drums allow for mixing panel types
 - Insulated glass at exterior
 - Flat glass at interior

Table of Contents

Revolving Door Systems

Automatic Revolving Doors

Grand® 2W Two-Wing	6
Grand® Core Vestibule Design.....	6
MiniGrand® Center Pivot Vestibule Design	7
AutoFlow™ Center Pivot Vestibule Design	7
ClearFlow™ Automatic Center Pivot – All Glass System.....	7

Security Revolving Doors

ControlFlow™ One-Way Automatic Security Revolving Door	8
ControlFlow™ One-Way Airport Automatic Exit Airport Security	8
ControlFlow™ Two-Way With Anti-Tailgate Security	9
ControlFlow™ Two-Way With Anti-Tailgate Security and Anti-Piggyback Security	9
Activating Switches	9

Manual Revolving Doors

EasyFlow™ Manual Revolving Door System	10
ClearFlow™ All-Glass Revolving Door System	10

Tools For Saving Money With Revolving Doors

Estimating Energy Savings.....	11
Quick Reference Guide	11

Revolving Door Systems



Beautiful • Brilliant • Energy Efficient

Government



Healthcare



Education





Pharmaceutical



Airport



Retail



Commercial



Hospitality



Quick Reference



Passport



Revolving Door Videos



MIT Study



Automatic Revolving Doors



Horton Automatics revolving door systems offer impressive architectural appeal, energy efficiency and effective high traffic management.

Five major designs are offered in a wide selection of finishes, diameters, door wing configurations and glazing options.

Standard Features

- Constant seal helps reduce energy costs
- Segmented® or round drum design
- Magnetic breakaway door wings for emergency egress
- Bump-To-Idle™ for added safety
- Easily adjustable manual or automatic rotation
- One-way, two-way or card access security
- Easy manual operation during power outages
- Most models are easily customized with all glass, solid wood and stainless steel materials plus special roof panel designs and extended canopies
- Compliant with ANSI 156.27 revolving door standard

Optional Features

- Quadrant heater for interior comfort in cold climates

Applications

High Traffic, Energy Efficiency, Security

- Airports
- Hospitals
- Hotels
- Schools
- Restaurants
- Manufacturing Facilities
- Financial/Government
- Shopping Malls and Retail
- Upscale Condominiums
- Call Centers



Grand® 2W

Two-Wing

Available in narrow or medium stiles, the Grand® 2W is available in systems up to 16 feet handling heavy pedestrian traffic up to 80 people per minute. The Grand® 2W is ideal for healthcare, corporate headquarters, airports and retail applications.

Standard Features

- Round drum design
- Narrow or medium stile
- Integrated sliding doors in place of center or core shaft
- Program selector to change rotation speeds to accommodate facility users as weather dictates

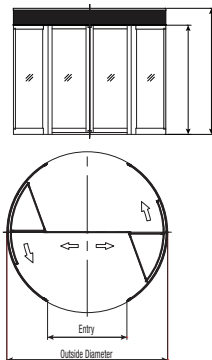

Two-Wing Round Drum



Grand®

Core Vestibule Design

This system provides spacious compartments for an elegant, energy efficient entrance. With diameters up to 16 feet, this system is ideal for managing high traffic volumes including wheelchairs, walkers and stretchers.

Standard Features

- Segmented® or round design
- Smooth, continuous rotation
- Auto rotation with VistaScan™*
- Customizable voice annunciator

Optional Features

- Quadrant heater

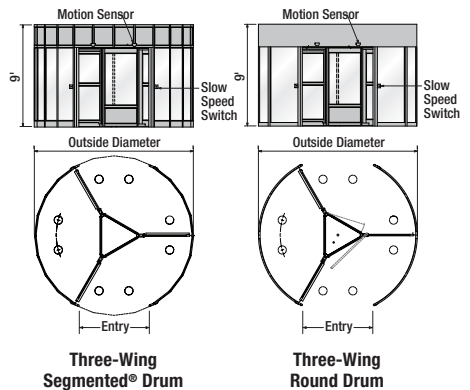



Three-Wing Segmented® Drum

Three-Wing Round Drum



*VistaScan™ slows or stops doors in motion when objects are within 8 to 12 inches of the door wings

Selection Guide

Model	Type	Outside Diameter	Segmented® Drum Throat Opening	Round Drum Throat Opening
 Grand® 2W	Two-Wing	12' 1" to 16' 19/64" (3684-4884)	—	5' 10 7/8" to 7' 10 1/2" (1800-2400)
 Grand®	Three-Wing	12' to 16' (3658-4877)	5' 3 3/4" to 7' 3 3/4" (1619-2229)	5' 1 1/4" to 7' 1 1/4" (1565-2175)



Grand® 2W
Landing
Page



Grand®
Landing
Page



MiniGrand®

Center Pivot Vestibule Design

The MiniGrand® offers the drum construction of a Grand® revolver along with the compact design made possible by center pivot door wings. This versatile door system is available in 11 and 12 foot diameters.

Standard Features

- Segmented® or round drum design
- Smooth continuous rotation
- Auto rotation with VistaScan™*

Optional Features

- Quadrant heater

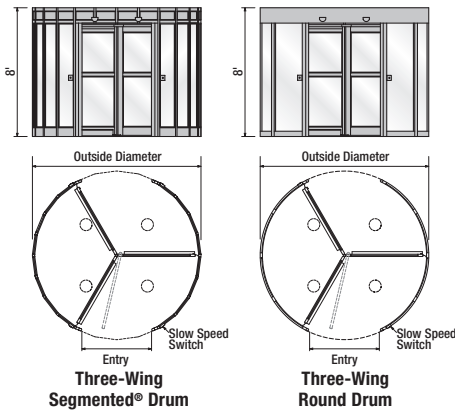

AutoFlow™

Center Pivot Vestibule Design

The AutoFlow™ is available in a 10-foot diameter configuration, it allows for easy movement of pedestrian traffic with reduced overall space requirements.

Standard Features

- Segmented® or round drum
- Excellent alternative to swing or slide door for a front entrance
- Smooth continuous rotation

Optional Features

- Quadrant heater

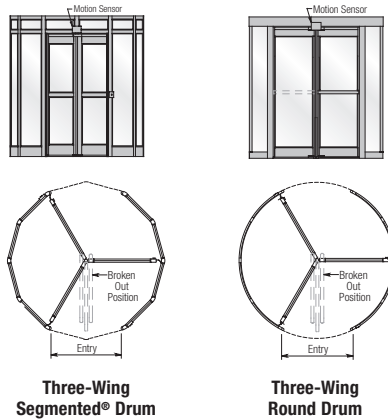

ClearFlow™ Automatic*

Center Pivot – All Glass System

Designed to blend with all-glass façades, the ClearFlow™ Automatic is an excellent solution for the awe-inspiring design.

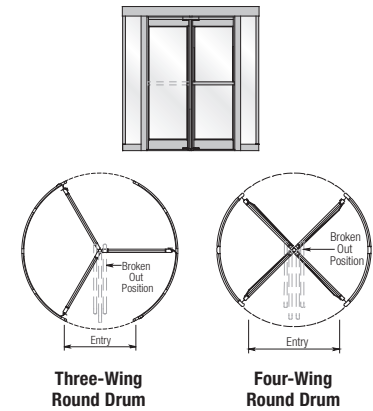

Standard Features

- Round design
- Available in three or four-wing configurations
- Electronic anti-collision light screen system to ensure pedestrian safety



*Consult your local authority's housing jurisdiction before specifying an all glass requirements.

Selection Guide

Model	Type	Outside Diameter	Segmented® Drum Throat Opening	Round Drum Throat Opening
 MiniGrand®	Three-Wing	11' to 12' (3353–3658)	4' 9¼" to 5' 3¾" (1467–1619)	4' 7⅞" to 5' 1⅝" (1413–1565)
 AutoFlow™	Three-Wing	10' 3½" (3137)	4' 4¼" (1340)	4' 7⅞" (1407)
 ClearFlow™ Automatic	Three-Wing	10' (3048)	—	4' 7⅞" to 4' ¾" (1230–1220)



MiniGrand®
Landing
Page



AutoFlow™
Landing
Page



ClearFlow™
Automatic
Landing
Page

Security Revolving Doors



Horton Automatics security revolving doors are versatile to handle standard to high security applications.

Standard Features

- Constant seal helps reduce energy costs
- Matless configurations
- One-way or two-way card access security
- Biometric, card or sensor activation

Applications

- Airports
- Pharmaceutical Companies
- Laboratories
- Financial Institutions
- Government Agencies
- Corporate Headquarters

ControlFlow™ One-Way Automatic Security Revolving Door

Designed for moving people from secure to non-secure areas, to ensure security breaches do not occur.

Standard Features

- Segmented® or round
- Medium stile design
- Field programmable voice messages
- Wireless remote set-up with 16 modes of operation and other programmable options

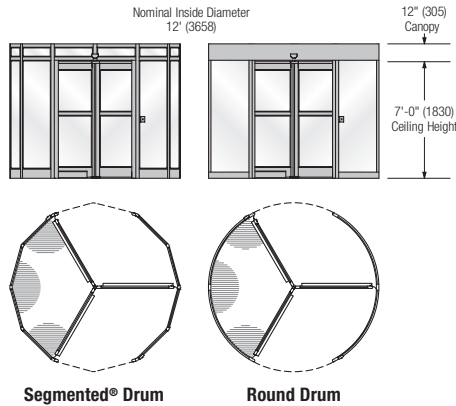



ControlFlow™ One-Way Airport Automatic Exit Airport Security

Designed specifically for airport applications to protect against security breaches in one-way traffic patterns.

Standard Features

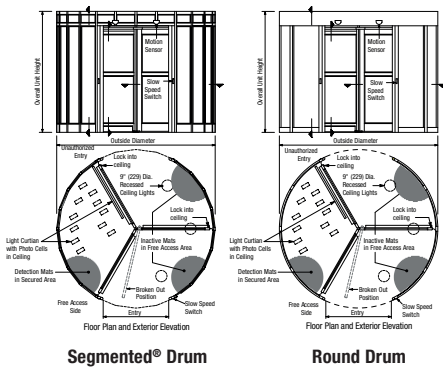
- Segmented® or round designs
- Medium stile design
- Field programmable voice messages
- Object detection technology to detect undesirable and dangerous objects



Selection Guide		Outside Diameter	Segmented® Drum Throat Opening	Round Drum Throat Opening
	ControlFlow™ One-Way	Three-Wing	8' 3½" to 10' 3½" (2527-3137)	3' 4¾" to 4' 4¾" (1026-1330)
	ControlFlow™ One-Way Airport	Three-Wing	12' (3658)	5' 3¼" (1619)
				3' 6¾" to 4' 6¾" (1089-1394)
				5' 1½" (1565)



ControlFlow™ One-Way Landing Page



ControlFlow™ One-Way Airport Landing Page



ControlFlow™ Two-Way With Anti-Tailgate Security

Designed with a choice of one or two-way card activation with a number of options including Level III bullet resistant glass and a matless system for aesthetic appeal.

Additional Features

- Segmented® or round design
- Three or four-wing configuration
- Narrow stile
- Wireless programming option
- Anti-tailgating design

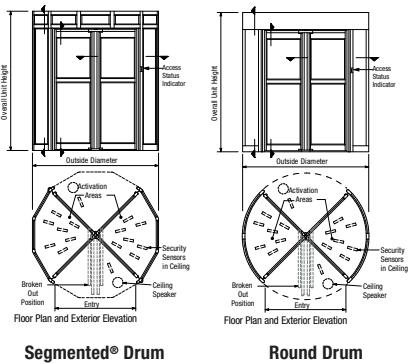

ControlFlow™ Two-Way With Anti-Tailgate and Anti-Piggyback Security

The ControlFlow™ two-way security system includes anti-tailgating and also anti-piggybacking capabilities. The system can be tailored to meet the level of security you require.

Additional Features

- Segmented® or round design
- Narrow stile
- Date/time overlay on video when detecting tailgating and piggybacking violations
- User-selectable security levels for detecting single and multiple people and suspicious activity

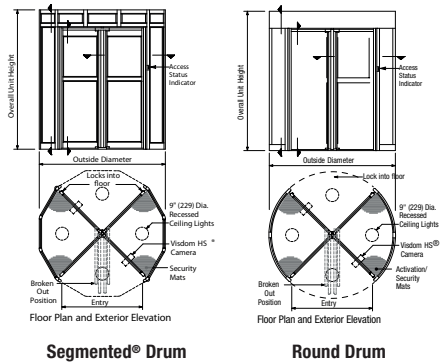



Activating Switches

Horton specialists will help you specify the correct switch for your requirements, including:

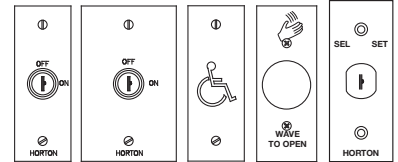
- Round or square metal push plates
- Push-button
- Keyless digital-code entry
- Key switch
- Contact mat
- Touchless photoelectric wall switch
- Explosion-proof solid state switch



Selection Guide

Model	Type	Outside Diameter	Segmented® Drum Throat Opening	Round Drum Throat Opening
 ControlFlow™ Two-Way Anti-Tailgating	Four-Wing	6' 3½" to 7' 3½" (1918–2223)	3' 10" to 4' 6¼" (1168–1391)	3' 10¼" to 4' 7¾" (1191–1406)
 ControlFlow™ Two-Way Anti-Tailgating/Anti-Piggybacking	Four-Wing	6' 3½" to 7' 3½" (1918–2223)	3' 10" to 4' 6¼" (1168–1391)	3' 10¼" to 4' 7¾" (1191–1406)



ControlFlow™
Two-Way
Landing Page



ControlFlow™
Two-Way
Landing Page

Manual Revolving Doors



Horton Automatics manual revolving door systems are an energy efficient alternative to automatic revolving door systems. Available in segmented®, round or all-glass configurations.

Standard Features

- Constant seal helps reduce energy costs
- Segmented® or round drum design
- Easily adjustable manual rotation
- Customizable configurations
- Speed control

Optional Features

- Available with quadrant heater for interior comfort in cold climates

Applications

- Retail
- Restaurants
- Hotels
- Office Buildings
- Government Facilities
- Schools and Libraries

EasyFlow™ Manual Revolving Door System

An outstanding choice for energy efficiency along with architectural appeal, the EasyFlow™ series is offered in a variety of configurations to suit any installation requirement. Each system includes Horton's proven mechanical speed control and book-fold hardware for emergency egress.

Standard Features

- Segmented® or round drum design
- Four standard diameters ranging from six to eight feet
- Curved tempered or laminated wall glass
- Push bars or muntins
- Choice of finishes
- Speed control

Optional Features

- Quadrant heater

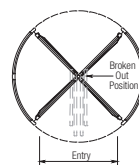
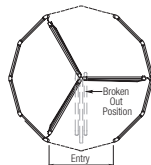
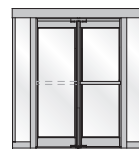

Three-Wing Segmented® Drum

Four-Wing Round Drum



ClearFlow™ Manual* All-Glass Revolving Door System

Designed for accentuating high volume traffic applications. Built with a center point design, the ClearFlow™ is ideal for accentuating the inner beauty of a building and is a good alternative to an automatic all-glass system.

Standard Features

- Round Design
- Available in three or four-wing configurations
- All glass

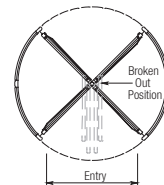
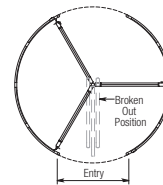



Three-Wing Round Drum

Four-Wing Round Drum



* Consult your local authority's housing jurisdiction before specifying an all glass requirements.

Selection Guide

Model	Type	Outside Diameter	Segmented® Drum Throat Opening	Round Drum Throat Opening
 EasyFlow™	Three-Wing	6' 9½" to 8' 3½" (2070–2514)	3' ½" to 3' 9" (918–1143)	3' ½" to 3' 9½" (918–1146)
	Four-Wing	6' 3½" to 8' 3½" (1918–2527)	4' 2½" to 5' 7½" (1280–1724)	4' ¾" to 5' 5¼" (1238–1670)
 ClearFlow™ Manual	Three/Four-Wing	6' to 10' 8" (1829–3251)	—	4' 7/16" to 4' 3/4" (1230–1220)



EasyFlow™
Landing
Page



ClearFlow™
Manual
Landing Page

Quick Reference Guide

AUTOMATIC REVOLVING DOORS									
Model	Number of Wings	Center Design	Drum Design	Outside Diameter	Unit Height	Ceiling Height	Canopy Height	Throat Opening	Persons Per Minute
Grand® 2W	2	Sliding Door	Round	12' 1" to 16' 1 ⁹ / ₁₆ " (3684–4884)	8' 5 ³ / ₁₆ " (2575)	7' 6 ⁹ / ₁₆ " (2300)	11" (279)	5' 10 ⁷ / ₁₆ " to 7' 10 ¹ / ₂ " (1800–2400)	80
Grand®	3	Center Core	Segmented® or Round	12' to 16' (3658–4877)	9' (2743)	7' (2134)	2' (610)	5' 1 ⁵ / ₁₆ " to 7' 3 ³ / ₄ " (1565–2229)	40
MiniGrand®	3	Center Shaft	Segmented® or Round	11' to 12' (3353–3658)	8' (2438)	7' (2134)	1' (305)	4' 7 ⁵ / ₁₆ " to 5' 3 ³ / ₄ " (1413–1619)	40
AutoFlow™	3	Center Shaft	Segmented® or Round	10' 3 ¹ / ₂ " (3137)	8' (2438)	7' (2134)	1' (305)	4' 4 ¹ / ₄ " to 4' 7 ⁵ / ₁₆ " (1340–1407)	24
ClearFlow™ Automatic	3	Center Pivot	Round	10' (3048)	7' 8 ³ / ₁₆ " (2346)	7' 6 ⁹ / ₁₆ " (2296)	1' 1 ¹ / ₁₆ " (325)	4' 7 ⁵ / ₁₆ " to 4' 3 ³ / ₄ " (1230–1220)	24

SECURITY REVOLVING DOORS									
Model	Number of Wings	Center Design	Drum Design	Outside Diameter	Unit Height	Ceiling Height	Canopy Height	Throat Opening	Persons Per Minute
ControlFlow™ One-Way	3	Center Shaft	Segmented® or Round	8' 3 ¹ / ₂ " to 10' 3 ¹ / ₂ " (2527–3137)	8' (2438)	7' (2134)	1' (305)	3' 4 ³ / ₈ " to 4' 6 ¹ / ₁₆ " (1026–1394)	36
ControlFlow™ One-Way Airport	3	Center Shaft	Segmented® or Round	12' (3658)	8' (2438)	7' (2134)	1' (305)	5' 1 ⁵ / ₁₆ " to 5' 3 ³ / ₄ " (1565–1619)	36
ControlFlow™ Two-Way Anti-Tailgating	4	Center Shaft	Segmented® or Round	6' 3 ¹ / ₂ " to 7' 3 ¹ / ₂ " (1918–2223)	8' (2438)	7' (2134)	1' (305)	3' 10" to 4' 7 ⁵ / ₁₆ " (1168–1406)	12
ControlFlow™ Two-Way Anti-Tailgating/ Anti-Piggybacking	4	Center Shaft	Segmented® or Round	6' 3 ¹ / ₂ " to 7' 3 ¹ / ₂ " (1918–2223)	8' (2438)	7' (2134)	1' (305)	3' 10" to 4' 7 ⁵ / ₁₆ " (1168–1406)	12

MANUAL REVOLVING DOORS									
Model	Number of Wings	Center Design	Drum Design	Outside Diameter	Unit Height	Ceiling Height	Canopy Height	Throat Opening	Persons Per Minute
EasyFlow™	3	Center Shaft	Segmented® or Round	6' 9 ¹ / ₂ " to 8' 3 ¹ / ₂ " (2070–2514)	Up to 9' Up to (2743)	Up to 9' Up to (2743)	4" or 6" (102 or 152)	3' 1 ¹ / ₈ " to 5' 7 ¹ / ₁₆ " (918–1724)	24
	4	Center Shaft	Segmented® or Round	6' 3 ¹ / ₂ " to 8' 3 ¹ / ₂ " (1918–2527)	Up to 9' Up to (2743)	Up to 9' Up to (2743)	4" or 6" (102 or 152)	3' 1 ¹ / ₈ " to 5' 7 ¹ / ₁₆ " (918–1724)	24
ClearFlow™ Manual	3 or 4	Center Pivot	Round	6' to 10' 8" (1829–3251)	7' 8 ³ / ₁₆ " (2346)	7' 6 ⁹ / ₁₆ " (2300)	1' 1 ¹ / ₁₆ " (325)	4' 7 ⁵ / ₁₆ " to 4' 3 ³ / ₄ " (1230–1220)	24

Estimate the Energy Savings Online

Determine the energy savings, CO₂ emissions, and payback of using Horton revolving doors!

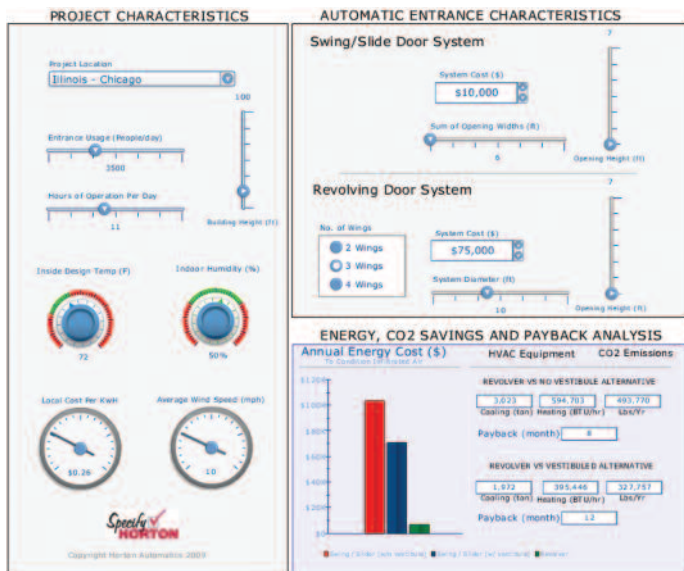

Compare the energy savings of using a revolving versus a swing and/or slide door system. Also see how much a revolving door reduces carbon dioxide emissions and provides rapid return on investment. Increase energy savings by specifying a Horton Revolving Door.

To use the calculator, scan this QR Code:



Requires Adobe Flash Player



Did You Know?

A 2006 MIT study concluded that revolving doors act as airlocks minimizing a building's heating and air conditioning losses. According to the study, revolving doors generate energy savings up to 74% when compared to other entrance alternatives.

Setting The Standards For Professional Installation And Service



Horton Automatics brings you the professional support of factory-authorized distributors. Whether your application involves a single automatic operator or a complete facility access and security plan, you can expect all phases of the project to be handled professionally.

All Horton systems are built to exceed applicable quality and safety standards including:

- ANSI standards for pedestrian doors
- 1990 ADA requirements for barrier-free entrances
- Compliant to UL 1784 to meet National Fire Protection Association (NFPA) regulations
- National building codes related to emergency exits
- American Testing Laboratory ratings for wind load and forced entry
- CSA, IBC, BOCA, Miami-Dade and other regional requirements
- Listed by Intertek (ETL) for compliance to UL 325 Electrical Door, Drapery, Gate, Louver, and Window Operators and Systems

Call your Horton Automatics distributor today for design, specification and application assistance. Visit www.hortondoors.com to find the nearest distributor in your area.

AAADM *American Association of Automatic Door Manufacturers*

Specify Horton and demand AAADM certified installation.



**Horton Automatics
World Headquarters**
4242 Baldwin Boulevard
Corpus Christi, Texas 78405-3399 USA
Phone: 800-531-3111, 361-888-5591
Fax: 361-888-6510
www.hortondoors.com

**Horton Automatics, Ltd.
United Kingdom**
Unit A, Hortonwood 31
Telford, Shropshire, England TF1-7YZ
Phone: 01952 670169
Fax: 01952 670181



Horton Automatics is a division of Overhead Door Corporation, an innovative industry leader with many firsts in upward-acting doors and electric openers for residential as well as commercial applications.

